



SHADOW

142L

Line Array Speaker System

APPLICATIONS

- Indoor or outdoor applications
- Convention centers
- Athletic fields
- Stadiums
- Theme parks
- Swimming pools

KEY FEATURES

- 2-way loudspeaker system
- 14" woofer with 3" coil
- 2 x 1,4" HF driver with 2,5" coil
- Sturdy molded polyethylene curved enclosure
- IP55 weather resistant
- Standard grey finish
- Completely manufactured in Italy

IP55
WEATHER
RESISTANT

PRODUCT DESCRIPTION

The SHADOW 142L is a weatherproof full range two way loudspeaker system offering substantial power and efficiency for a variety of professional indoor or outdoor applications. The low frequency transducer is a 14" woofer with a 3" voice coil. The high frequency section is a constant directivity horn loaded to 2 x 4" driver with a 2,5" coil. Line array configuration make the SHADOW 142L perfect for all indoor or outdoor installations where long throw full range sound reproduction is required. The cabinet is a single piece rotational moulded in polyethylene, fully UV protected. The water-stop grille is in custom perforated aluminium with 3 layers of protection. The SHADOW 142L meets the requirements of IP55 code (International Protection Rating).

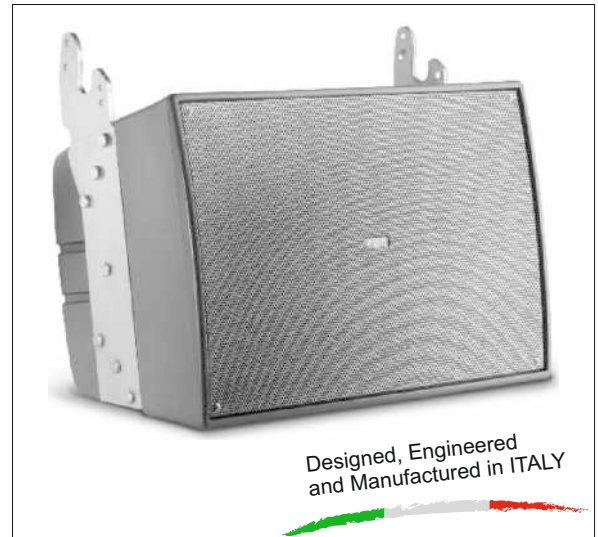

ELECTRONIC SPECIFICATIONS

System Type	2 Way
Recommended Amplifier	1000W RMS
System Long Term Power	500W
System Short Term Power (IEC 268-5)	2000W
Nominal Impedance	8 Ohm
Frequency Response	60Hz - 20kHz (@-6dB)
Sensitivity (LF / HF)	98dB / 110dB (@1W, 1m)
Max SPL (cont/peak) (bi-amp)*	126,5dB / 137dB
Dispersion	100°H x 15°V
Crossover Frequency	1.2kHz
Recommended HP Filter	40Hz - 24dB oct.

PHYSICAL SPECIFICATIONS

Low Frequency Woofer	14" / 3" coil
High Frequency Driver	2 x 1,4" / 2,5" coil
Input Connectors	2 x XLR
Net Dimensions (WxHxD) inch	24,21 x 16,92 x 16,33
Shipping Dimensions (WxHxD) inch	21,85 x 30,11 x 21,25
Net Weight	83,7 lbs
Shipping Weight	88,2 lbs
Enclosure Material	Polyethylene rotomoulded
Grille	Custom perforated aluminium

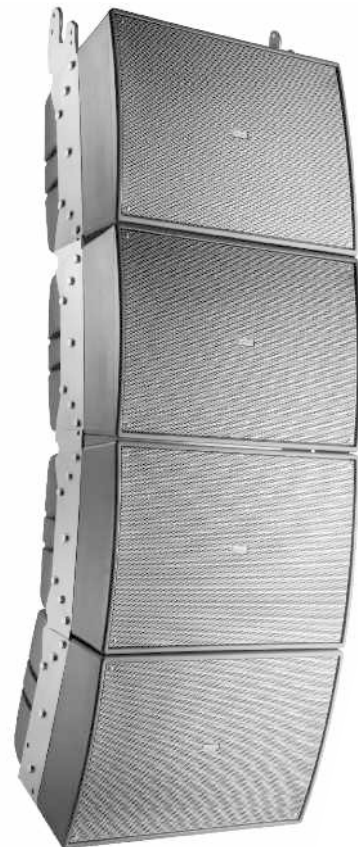

* CONT. SPL: free space, based on recommended amp rating and LF transducer average sensitivity data, 125ms time average
PEAK SPL: free space, based on short term applicable power rating and system peak sensitivity, 10ms time average

Horizontal polar diagrams

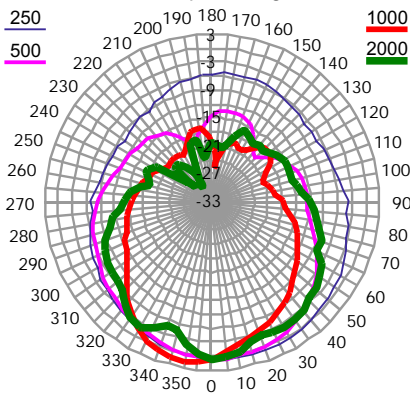

Horizontal polar diagrams

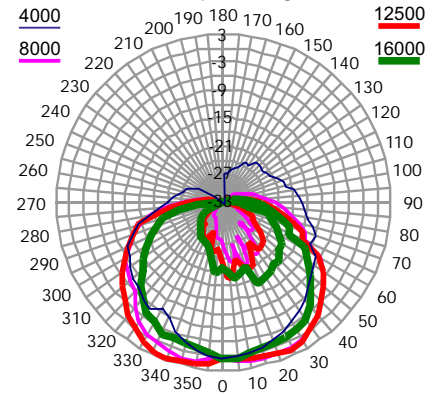

Vertical polar diagrams

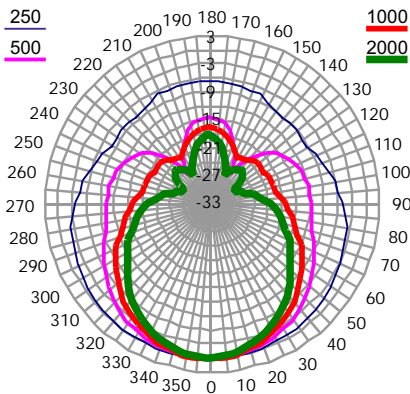

Vertical polar diagrams

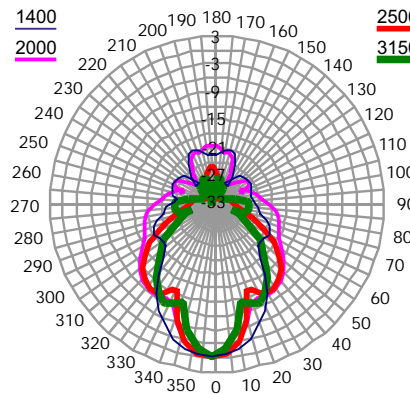

Vertical polar diagrams

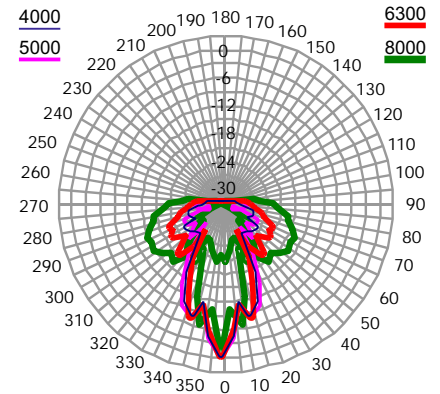

Vertical polar diagrams

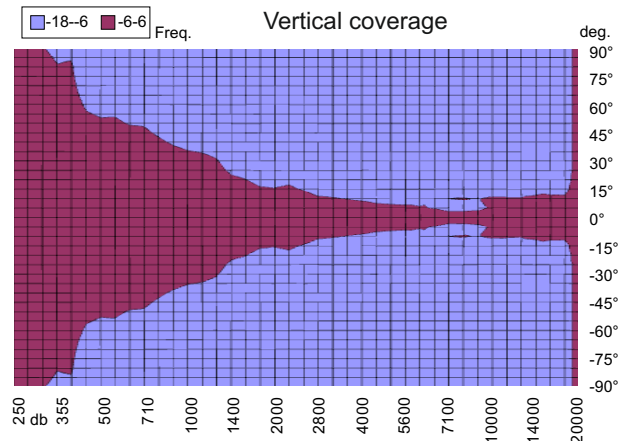
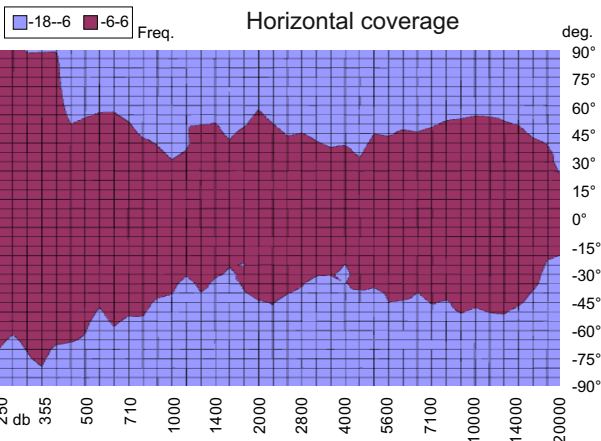
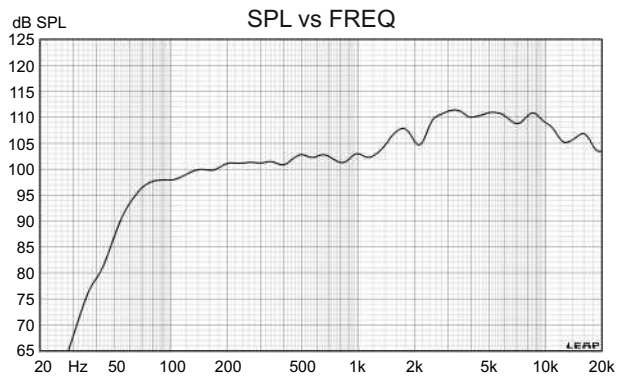
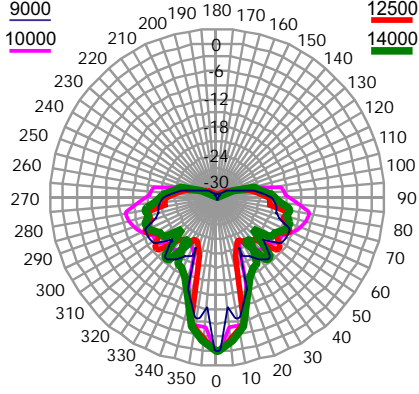

DIMENSIONAL DRAWINGS

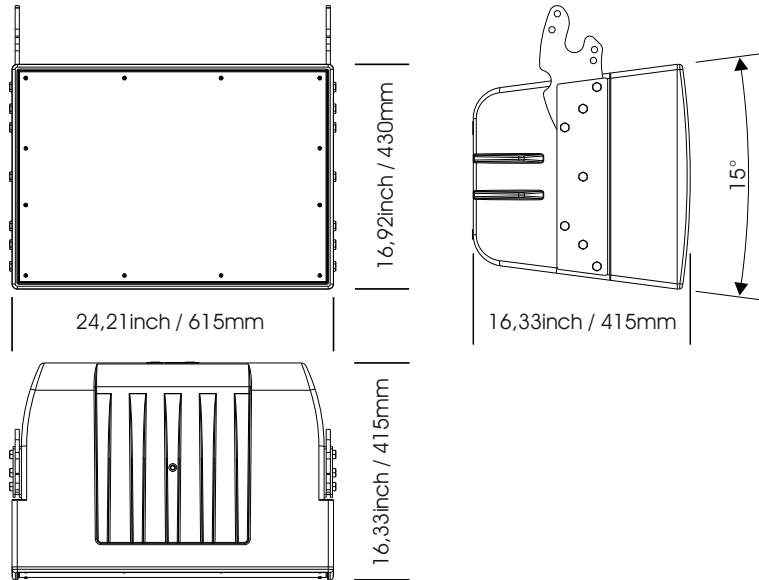

TECHNICAL SPECIFICATIONS LABEL

SHADOW FBT 142L ALL WEATHER LOUSPEAKERS	
Connections: 1 - IN + 2 - IN - 3 - nc 4 - nc	Recommended Amplifier: 1000W System Long Term Power: 500W Dispersion: 100° x 15° Frequency Response: 60Hz-20kHz Nominal Impedance: 8 Ohm
MADE IN ITALY	

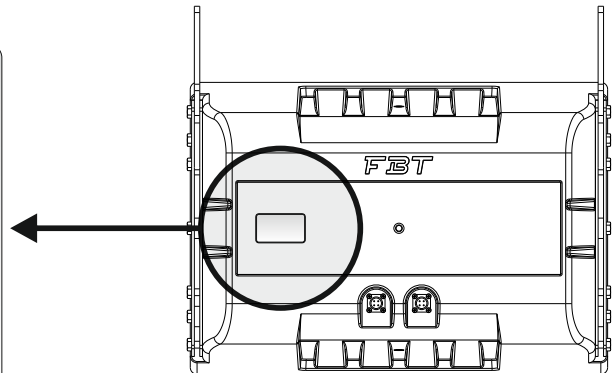

SUPPLIED ACCESSORY

SW-F142
flying bar for rigging

